

MODEL	MHXLD-CEP-810	SERIAL NUMBER	SAMPLE
--------------	----------------------	----------------------	---------------

REFERENCE TO OCCUPATIONAL SAFETY AND HEALTH ADMINISTRATION RULES AND REGULATIONS, 29 CFR, NO 209, PART 1926, SUBPART P

SHIELD SIZE		PSF RATING	MAXIMUM ALLOWABLE DEPTH OF CUT (FEET) SOIL TYPE TO BE EXCAVATED		
-------------	--	------------	--	--	--

HEIGHT (FEET)	LENGTH (FEET)	MAXIMUM LATERAL EARTH PRESSURE CAPACITY AT TRENCH BOTTOM IN POUNDS PER SQUARE FOOT	TYPE B MEDIUM COHESIVE TO GRANULAR SOIL 45 PSF PER FOOT OF DEPTH	TYPE C-60 SOFT COHESIVE TO SUBMERGED CLAY SOIL 60 PSF PER FOOT OF DEPTH	TYPE C-60 SOFT NON COHESIVE TO SUBMERGED SANDY SOIL 60 PSF PER FOOT OF DEPTH
8	10	1980	44	40	33

LIMITATIONS IN USE OF TABLE

1. TRENCH SHIELD TO BE ASSEMBLED AND INSTALLED AS SHOWN AND IN ACCORDANCE WITH MANUFACTURER'S INSTRUCTIONS.
2. EXCAVATION 2 FEET BELOW BOTTOM OF SHIELD IS PERMITTED WHEN NO LOSS OF SOIL FROM BEHIND OR BELOW THE BOTTOM OF SHIELD IS ENCOUNTERED. SEE PARAGRAPH 1926.652 (e)(2)(i). THE COMPETENT PERSON SHALL MAKE THE DETERMINATION FOR COMPLIANCE. SUDDEN SHIFTING OF THE SHIELD VERTICALLY SHALL BE AVOIDED.
3. CONSULT MANUFACTURER WHEN RESTRICTION ON NOTE 2 IS NOT MET.
4. ADDITIONAL SHIELDS MAY BE STACKED WITH NO PENALTY IN DEPTH OF CUT AS LONG AS THE RATING OF THE BOTTOM SHIELD IS NOT EXCEEDED.
5. DEPTHS OF CUTS SHOWN ARE BASED ON EXAMPLES OF VARIOUS SOIL CONDITIONS. VERIFY ACTUAL SOIL PRESSURES PRIOR TO EACH USE.
6. ANY MODIFICATIONS OR ALTERATIONS NOT ALLOWED UNLESS APPROVED IN WRITING BY EFFICIENCY PRODUCTION, INC.
7. CONTRACTOR'S COMPETENT/QUALIFIED PERSON SHALL BE RESPONSIBLE FOR MONITORING SOIL CONDITIONS AND SHALL BE RESPONSIBLE FOR COMPLIANCE WITH ALL FEDERAL, STATE AND LOCAL RULES AND REGULATIONS.
8. SPREADER PINS SHALL BE AISI C-1018 60-75 KSI MIN. YIELD AND NO MORE THAN 1/4" SMALLER THAN COLLAR AND SPREADER PIN HOLES AS MANUFACTURED BY EFFICIENCY PRODUCTION, INC.

CONTINUED ON REVERSE SIDE

DESCRIPTION	DESCRIPTION	DESCRIPTION
CLAY, WITH UNCONFINED COMPRESSIVE STRENGTH GREATER THAN 0.5 TSF BUT LESS THAN 1.5 TSF COHESIONLESS GRAVEL, SILT, SILT LOAM OR SANDY LOAM	SOFT COHESIVE SOIL UNCONFINED COMPRESSIVE STRENGTH EQUAL TO 0.5 TSF CLAY, SAND AND LOAMY SAND; SUBMERGED SOIL THAT IS STABLE	SOFT COHESIONLESS SOIL UNCONFINED COMPRESSIVE STRENGTH LESS THAN 0.5 TSF GRAVEL, SAND AND LOAMY SAND; SUBMERGED SOIL OR FRACTURED ROCK THAT IS NOT STABLE

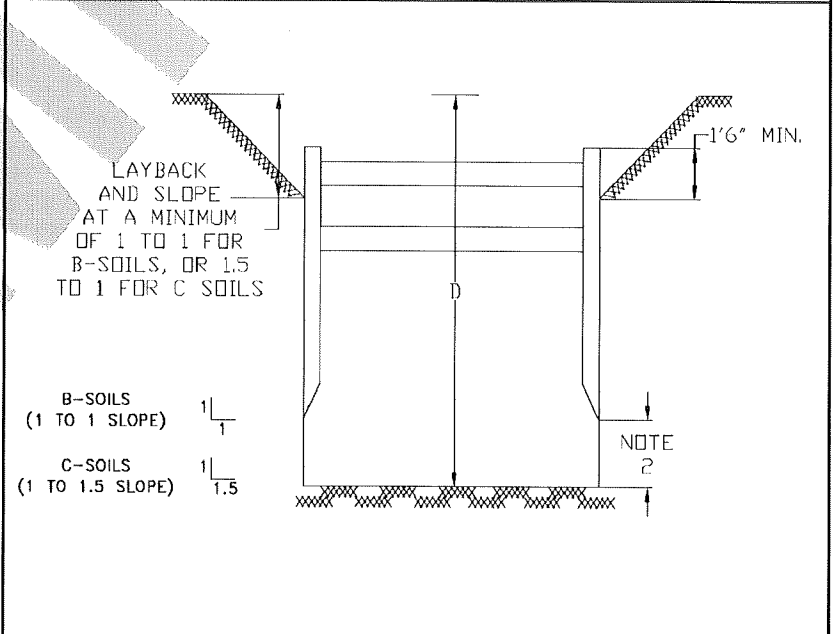

	CERTIFIED BY: EFFICIENCY PRODUCTION INC.	COPYRIGHT: 1991 EFFICIENCY PRODUCTION INC. ALL RIGHTS RESERVED
--	--	---

MANUFACTURED UNDER ONE OR MORE OF THE FOLLOWING U.S. PATENT NUMBERS: 4,090,365-4,114,383-4,259,028 ONE OR MORE OF THE FOLLOWING CANADIAN PATENT NUMBERS: 1,062,683-1,062,684

USE THIS PRODUCT ONLY IN ACCORDANCE WITH APPLICABLE FEDERAL, STATE OR LOCAL LAWS

ANY USE OF THIS PRODUCT NOT SPECIFICALLY DESCRIBED ON THIS CERTIFICATE COULD CAUSE IN CAVE-IN, COLLAPSE, OR STRUCTURAL FAILURE RESULTING IN DEATH OR SERIOUS INJURY

9. NOT TYPE A IF FISSURED, SUBJECT TO VIBRATION, PREVIOUSLY DISTURBED OR PART OF A SLOPED LAYERED SYSTEM WHERE LAYERS DIP INTO EXCAVATION ON A SLOPE OF FOUR HORIZONTAL TO ONE VERTICAL (4H:1V) OR GREATER.
10. PREVIOUSLY DISTURBED SOILS MAY BE TYPE B UNLESS THEY WOULD BE CLASSIFIED AS TYPE C. SOIL THAT MEETS REQUIREMENTS OF TYPE A, BUT IS SUBJECT TO VIBRATION OR FISSURED MAY BE TYPE B. DRY ROCK THAT IS NOT STABLE OR SOIL THAT IS PART OF A SLOPED, LAYERED SYSTEM WHERE LAYERS DIP INTO THE EXCAVATION ON A SLOPE LESS STEEP THAN FOUR HORIZONTAL TO ONE VERTICAL (4H:1V) ARE TYPE B BUT ONLY IF MATERIAL WOULD OTHERWISE BE CLASSIFIED AS TYPE B.
11. SOIL IN A SLOPED LAYERED SYSTEM WHERE LAYERS DIP INTO THE EXCAVATION ON A SLOPE OF FOUR HORIZONTAL TO ONE VERTICAL (4H:1V) OR STEEPER MAY BE TYPE C. SUBMERGED SOIL IS MATERIAL WITH WATER FREELY SEEPING AND ENTERING THE TRENCH, BUT ONLY PART OF THE DEPTH OF THE RETAINED SOIL IS SUBMERGED. CONDITIONS MORE SEVERE WOULD REQUIRE DEWATERING OR SEALING FOUR SIDES OF THE EXCAVATION AND PUMPING THE TRENCH. SUCH SEVERE CONDITIONS WOULD REQUIRE THE SERVICES OF A SOILS ENGINEER TO ESTABLISH THE DESIGN PRESSURE. CONSULT THE MANUFACTURER FOR PRESSURES EXCEEDING TABULATED VALUES.
12. ANY USE OF A TRENCH SHIELD WITHOUT EFFICIENCY SPREADERS AND PINS OR EQUAL WILL VOID THE TABULATED DATA AND WARRANTY.
13. SHIELD WAS DESIGNED TO BE USED WITHOUT PLATES EXTENDING BELOW, ABOVE, OR NEXT TO IT. ANY USE OF SUCH PLATES OR PANELS MAY VOID THE TABULATED DATA, AND MAY REQUIRE SITE SPECIFIC ENGINEERING.
14. TRENCH SHIELDS ARE DESIGNED TO BE PUSHED TO GRADE IF NECESSARY. AS NOTED BELOW, ANY UNNECESSARY ABUSE BY THE EXCAVATOR AND OR OPERATOR (SUCH AS POUNDING WITH THE BUCKET) WILL VOID THE TABULATED DATA AS WELL AS THE WARRANTY.
15. CONDITION OF SHIELD, SPREADER PIPES, AND SPREADER PINS MUST BE CHECKED/INSPECTED FOR SERVICEABILITY BY THE COMPETENT PERSON PRIOR TO EACH USE. PSF RATING IS NOT VALID IF THERE IS ANY VISIBLE DAMAGE TO, OR REPAIRS MADE TO THE SHIELD THAT HAVE NOT BEEN DOCUMENTED AND CERTIFIED BY A REGISTERED PROFESSIONAL ENGINEER.
16. DEPTH AND PSF RATINGS ARE FOR LATERAL EARTH PRESSURES ONLY AND DO NOT TAKE ANY SURCHARGES INTO ACCOUNT.

Assembly

Lay side panel flat on ground with collar sockets up ...

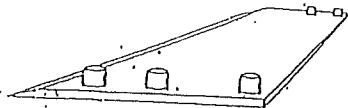

Place spreader pipe and/or plate onto collars or into brackets and pin in place. Secure pins with keepers.



Lower second sidewall onto spreaders and pin.

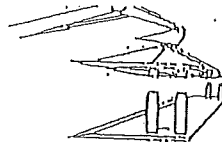

Stand trench shield in upright position and prepare for installation.

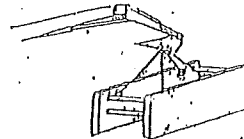

Mud Plate Spreader System 5 Pipe Spreader System 4 Pipe Spreader System

Using a trench shield in stable soil

Excavate to grade just slightly wider than the trench shield. Dig walls vertical to minimum of 18" below the top of the shield. Slope soil above shield according to manufacturers tabulated data. Install shield in trench.

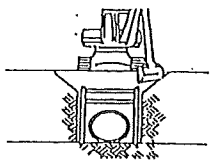

Excavate in front of the trench shield



Pull shield forward by front top spreader pipe or with pulling eyes. (pulling eyes shall be used with spreaders wider than 72" or when soil pressure is severe enough to cause spreader to deflect).

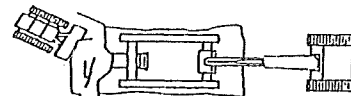

Using a shield in unstable soil

Excavate until soil begins to crumble beyond desired trench width. Place shield on line of excavation.

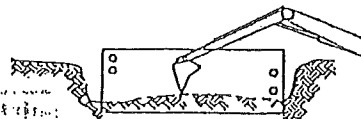

Press down on corners to push shield down to grade

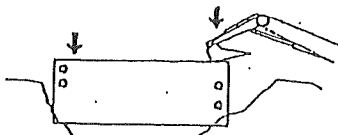

Pull shield forward and up on appropriate angle.

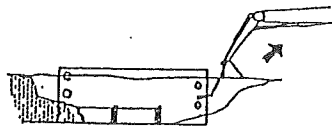

Excavate soil within the shield and repeat previous process.

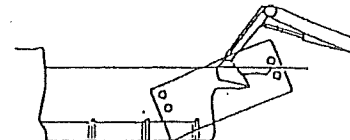

Using shields for patchwork, repairs or tie-ins

- * Center shield over work area.
- * Lay soil at ends back according to manufacturers tabulated data or use manufacturer's designed end plates to protect from cave-ins.

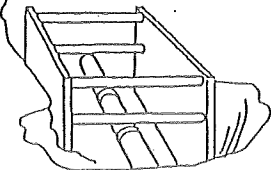

Manhole box with corner end plates

Corner end plates help prevent loose material from running into the end of the shield. Soil at ends should be sloped according to manufacturers tabulated data

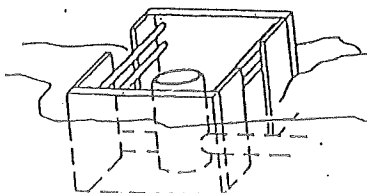

Using 4-sided shields

When using shields as protection during manhole assembly work, insure that proper end panels are used, or lay soil at the ends back according to manufactures tabulated data.

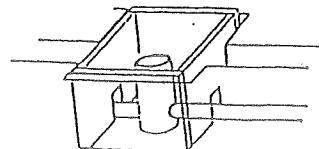

* This material is intended to provide basic assembly and installation information only.
 * Always use trench shield in accordance with applicable local, state, and federal safety laws and regulations. Failure to do so could cause severe injury or death.